

Luxaflex® Box Awnings

## Formosa Max

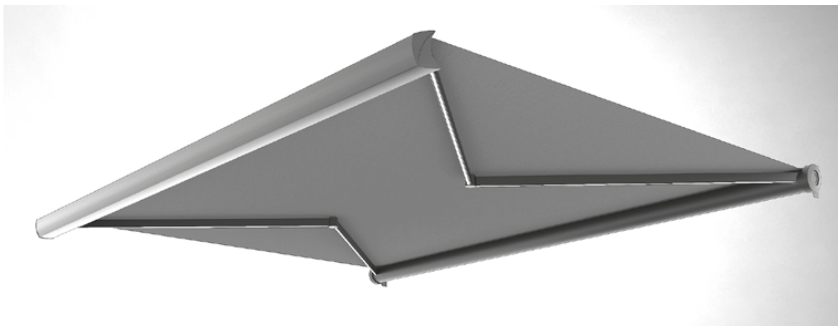

The Luxaflex® Formosa Max impresses with its elegant appearance and modern design. One set of arms is sufficient to shade an area of 600 x 400 cm.

An additional advantage of Formosa Max is the possibility of using modern LED lighting, in the arms and on the front rail which makes your terrace even more attractive and practical all year round.



**somfy.**

 0161 947 4930

 [shutters.awnings@luxaflex.co.uk](mailto:shutters.awnings@luxaflex.co.uk)



# Luxaflex® Box Awnings

## Formosa Max

Type: Standard Arm

Maximum width: 600 cm x 400 cm

Control:

230v electric - IO or RTS motors

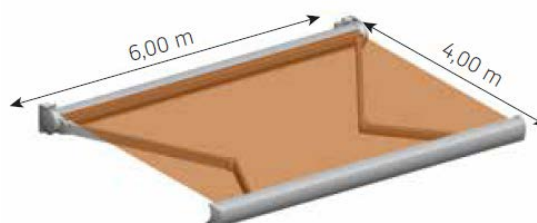

Wall mounting

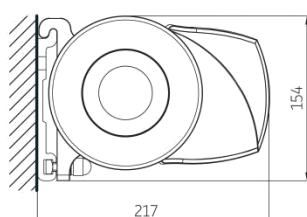

Ceiling mounting

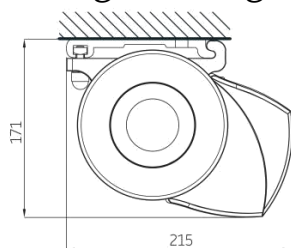

Standard arm



Arm with LED lights

reach cm	200	250	300	350	400
arms →	2	2	2	2	2
minimum width cm	239	289	339	389	439

**Available in 6 colours:**

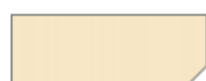

RAL 9001



RAL 9010

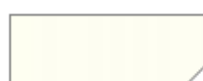

RAL 9016



RAL 7S16  
Surcharge: + 6%



Tiger 29/80081  
Surcharge: + 6%



RAL 9S07  
Surcharge: + 6%

# Notes page



A series of horizontal dotted lines spanning the width of the page, providing a guide for writing notes.



0161 947 4930



[shutters.awnings@luxaflex.co.uk](mailto:shutters.awnings@luxaflex.co.uk)

# Order form box awnings FORMOSA MAX



DATE: \_\_\_\_\_ REFERENCE: \_\_\_\_\_ ACCOUNT NO: \_\_\_\_\_

COMPANY: \_\_\_\_\_ CONTACT NAME: \_\_\_\_\_

DELIVERY ADDRESS: \_\_\_\_\_

\_\_\_\_\_

PHONE: \_\_\_\_\_

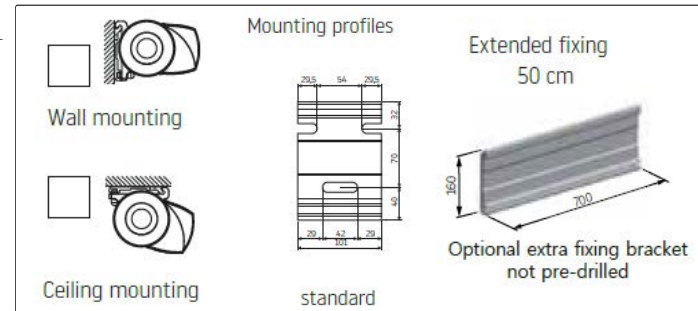

No	Width	Projection	qty	Dickson Orchestra		LED Lighting		Type of control		Valance		Extra options			
				Fabric number*	Stitched / Bonded	LED-Lighting arms	arms and front rail	motor Std IO or RTS	Control side **		28 cm	25 cm	Mounting		Extended fixing bracket 50 cm
									L	R			Wall Mount Standard	Ceiling Mount (Option)	
1															
2															
3															
4															
5															

\* Standard stitched    \*\* Operation side from outside

Colors: (Colour closest to RAL)

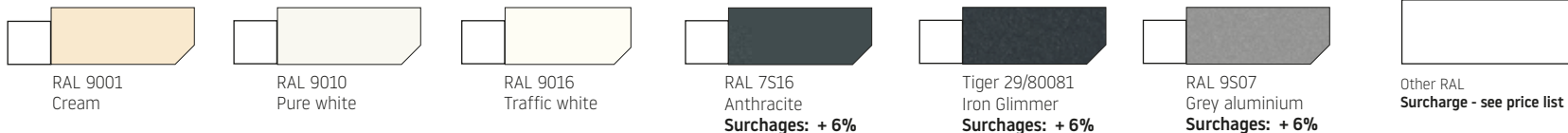

Remote control

Sensors

Notes

✉ e-mail: [shutters.awnings@luxaflex.co.uk](mailto:shutters.awnings@luxaflex.co.uk)

☎ telephone: 0161 947 4930

Orders can be placed via Luxaflex connect on-line - [www.luxaflexconnect.co.uk](http://www.luxaflexconnect.co.uk)